

Rev	Date
A	17 / 05 / 2023

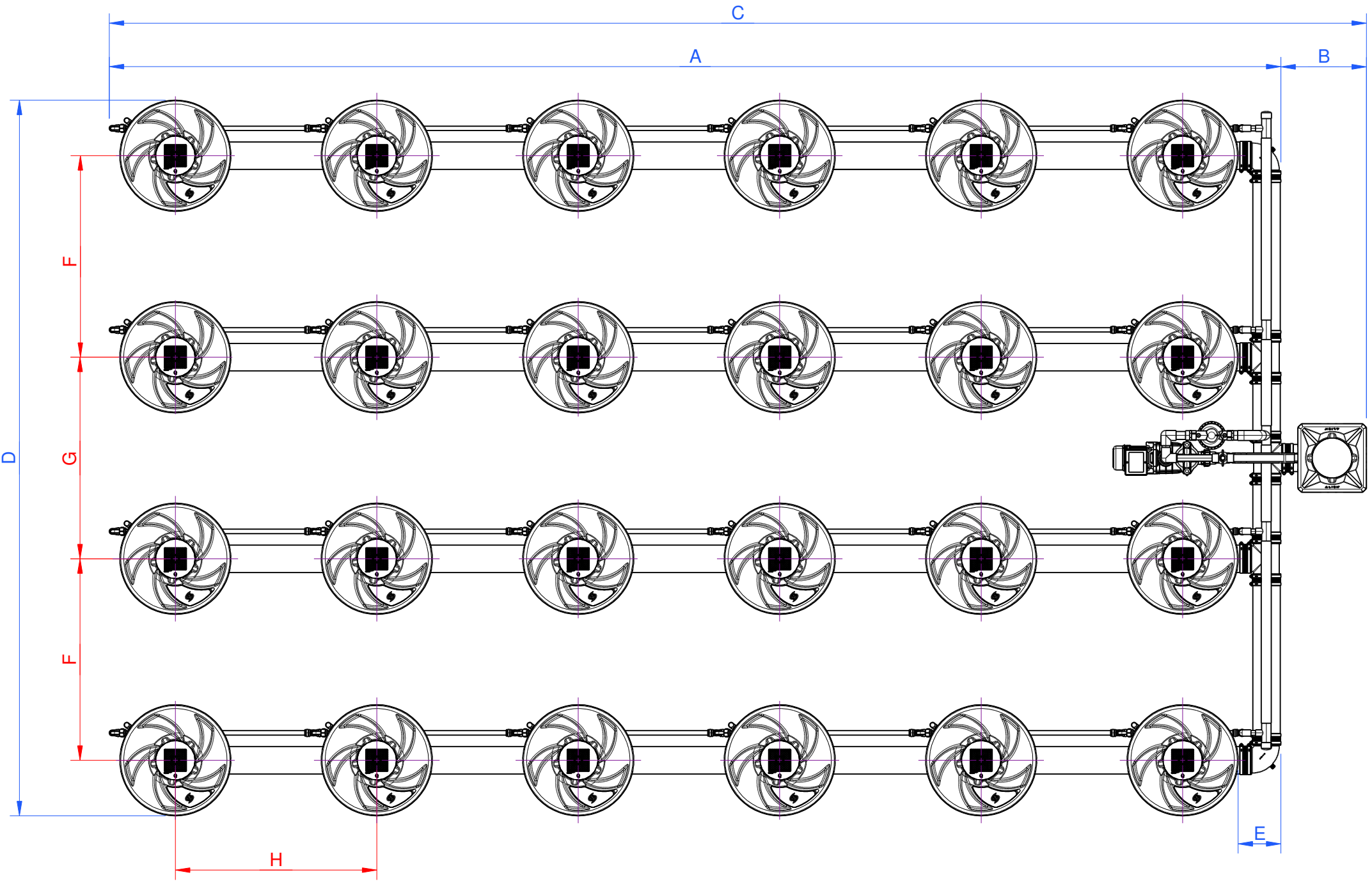

Inverted Header:

The header can be located inside the footprint as shown.

This option reduces overall length of system to dimension "A" (please refer to dimensions table).

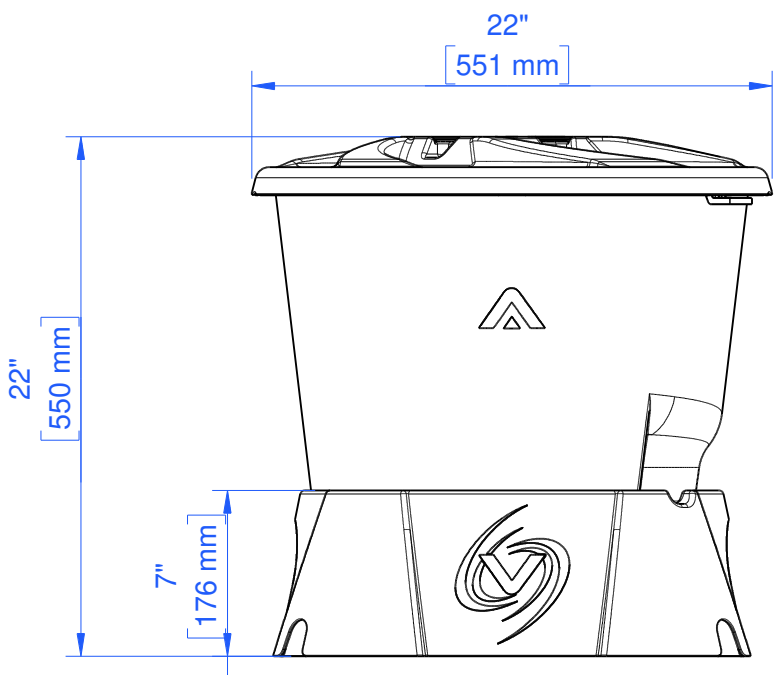
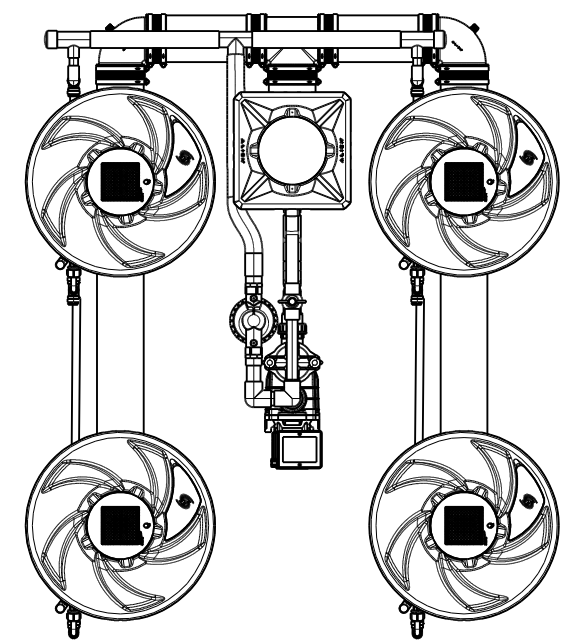

Dimensions	Minimum	Maximum @ 40" / 1m Plant Centers*
A	145" (3690mm)	229" (5820mm)
B	17" (420mm)	42" (1070mm)
C	162" (4110mm)	271" (6890mm)
D	91" (2300mm)	140" (3550mm)
E	8" (210mm)	8" (210mm)
F	22" (560mm)	40" (1000mm)
G	26" (650mm)	40" (1000mm)
H	23" (580mm)	40" (1000mm)

*** Note:**
Plant centers greater than 40" / 1m are possible with custom order lengths of 5" tubing, please contact sales@alienhydro.com for more details.



Project: V-SYSTEM	Scale 1 : 24
Title: 4 Row 24 Pot	
Drawing Number: V-4.24_US	Sheet 1 of 1